

### Strip Brush

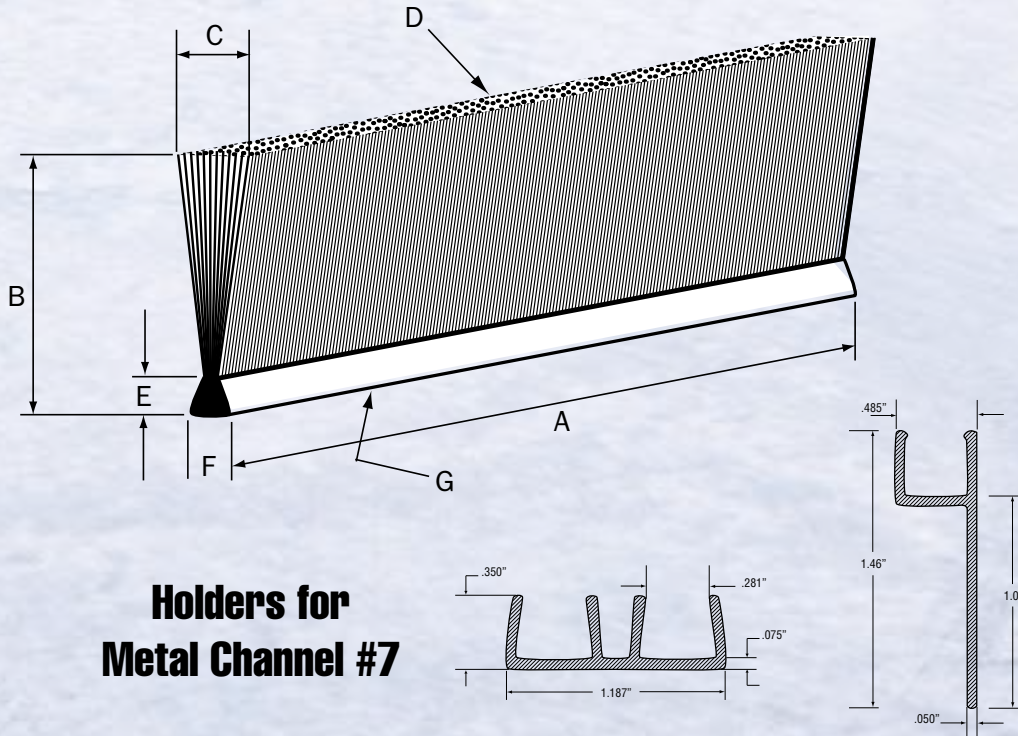

### Holders for Metal Channel #7

### Applications:

- Spreading of powdery materials
- Dusting
- Splash guard on grinders and machine tools
- Lag Brushes
- Eliminates static electricity
- Curtains to prevent hot chips from flying
- Noise/Wind barrier
- Product guide
- Many, many more uses

**Please provide all dimensions in Inches (indicate any critical tolerances)**

**A.** Brush Length: \_\_\_\_\_ **B.** Brush Overall Trim Height: \_\_\_\_\_

**C.** Brush Face Width (if applicable) \_\_\_\_\_ **D.** Bristle: (Poly, Nylon, Wire, Etc.) \_\_\_\_\_

Bristle Dia. \_\_\_\_\_ Colour \_\_\_\_\_ Crimped or Level \_\_\_\_\_

**E. & F.** Backing Height & Width: #4 = 3/16 X 3/16, #7 = 5/16 X 5/16



**G.** Backing Mat'l: Galvanized or Stainless \_\_\_\_\_

Quantity Required: \_\_\_\_\_

Any additional information or notes: \_\_\_\_\_

Your Company Name: \_\_\_\_\_ Phone: \_\_\_\_\_

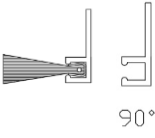
Your Name: \_\_\_\_\_ Title: \_\_\_\_\_ Fax: \_\_\_\_\_

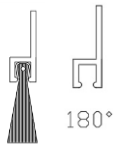
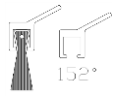
|   | NEW PART#         | CHANNEL #'S | DEGREE     | Backing Height | Availability |
|---|-------------------|-------------|------------|----------------|--------------|
| <br>45°    | CH#2.5-45         | 2.5         | 45         | 0.853          | Order In     |
|   | CH#712-45         | 7           | 45         | 1.430          | Order In     |
| <br>90°    | CH#2.5-90         | 2.5         | 90         | 0.650          | Order In     |
|   | <b>CH#412-90</b>  | <b>4</b>    | <b>90</b>  | <b>1.250</b>   | <b>STOCK</b> |
|   | CH#412-90         | 4           | 90         | 1.240          | Order In     |
|   | CH#412-90         | 4           | 90         | 1.250          | Order In     |
|   | CH#712-90         | 7           | 90         | 1.380          | Order In     |
| <br>Double | CH#712D           | 7           | 90         |                | Order In     |
|   | CH#712D           | 7           | 90         | 1.156          | Order In     |
| <br>180°  | CH#2.5-180        | 2.5         | 180        | 0.895          | Order In     |
|   | CH#2.5-180        | 2.5         | 180        | 0.660          | Order In     |
|   | <b>CH#2.5-180</b> | <b>2.5</b>  | <b>180</b> | <b>0.875</b>   | <b>STOCK</b> |
|   | CH#412-180        | 4           | 180        | 1.250          | Order In     |
|   | CH#412-180        | 4           | 180        | 1.240          | Order In     |
|   | <b>CH#412-180</b> | <b>4</b>    | <b>180</b> | <b>1.250</b>   | <b>STOCK</b> |
|   | CH#412-180L       | 4           | 180        | 2.150          | Order In     |
|   | CH#512-180        | 5           | 180        | 1.200          | Order In     |
|   | CH#512-180        | 5           | 180        | 1.094          | Order In     |
|   | <b>CH#712-180</b> | <b>7</b>    | <b>180</b> | <b>1.810</b>   | <b>STOCK</b> |
| <br>152° | CH#712-180        | 7           | 180        |                | Order In     |
|   | CH#712-180L       | 7           | 180        | 5.470          | Order In     |
|   | CH#4-152Deg       | 4           | 152        | 0.500          | Order In     |
|   | CH#2.5-15Deg      | 2.5         | 15         | 0.7274         | Order In     |

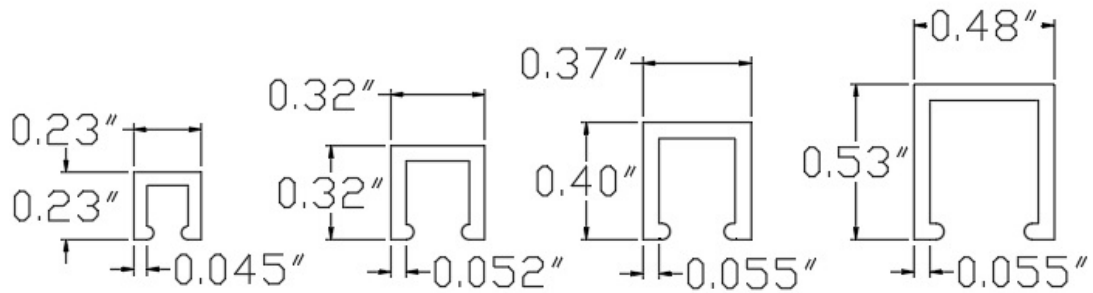

#2.5

#4

#5

#7